

EU-Funded Projects Roundtable

RE-SAMPLE Project Privacy Challenges

19.06.2023

Prof. Christos Kalloniatis, University of Piraeus

RE-SAMPLE DPO

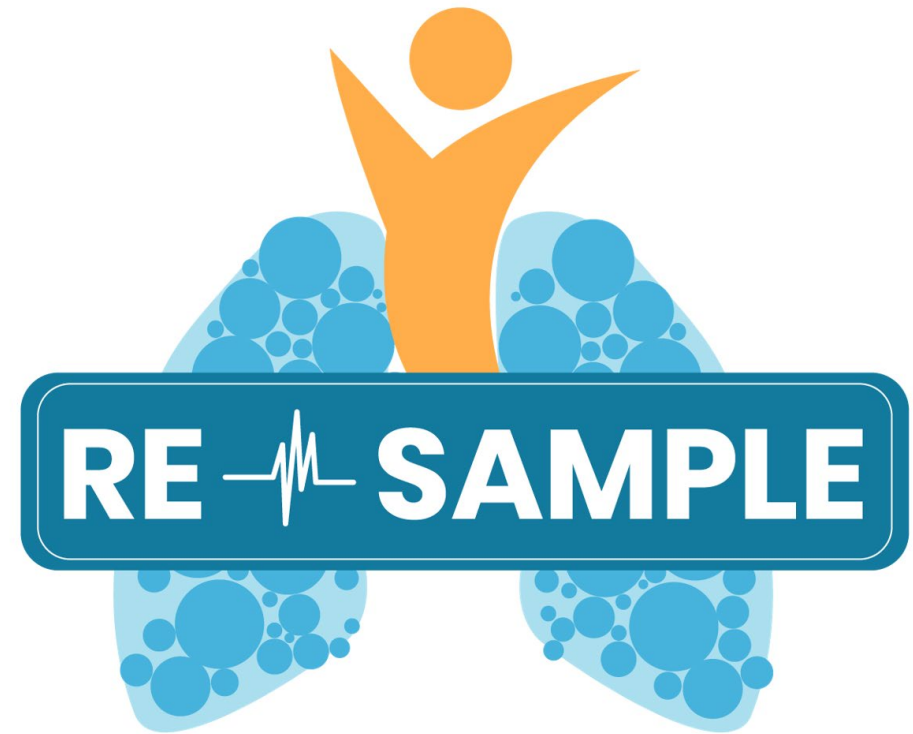

RE-SAMPLE has received funding from the European Union's Horizon 2020 research and innovation programme under Grant Agreement No 965315. SC1-DTH-12-2020: Use of Real-World Data to advance research on the management of complex chronic conditions. This result only reflects the author's view and the EU is not responsible for any use that may be made of the information it contains.

RE-SAMPLE - REAL-TIME DATA MONITORING FOR SHARED, ADAPTIVE, MULTI-DOMAIN AND PERSONALISED PREDICTION AND DECISION MAKING FOR LONG-TERM PULMONARY CARE ECOSYSTEMS

- **Video** about RE-SAMPLE: <https://youtu.be/lu44UotdmM0>

RE-SAMPLE

Our overall objective is to *identify individual multi-morbid CCC exacerbations and develop tailored referral to a multidisciplinary, adaptive virtual companionship programme* for patients with COPD and CCCs (i.e. diabetes mellitus, chronic heart failure, ischaemic heart disease, anxiety and/or depression).

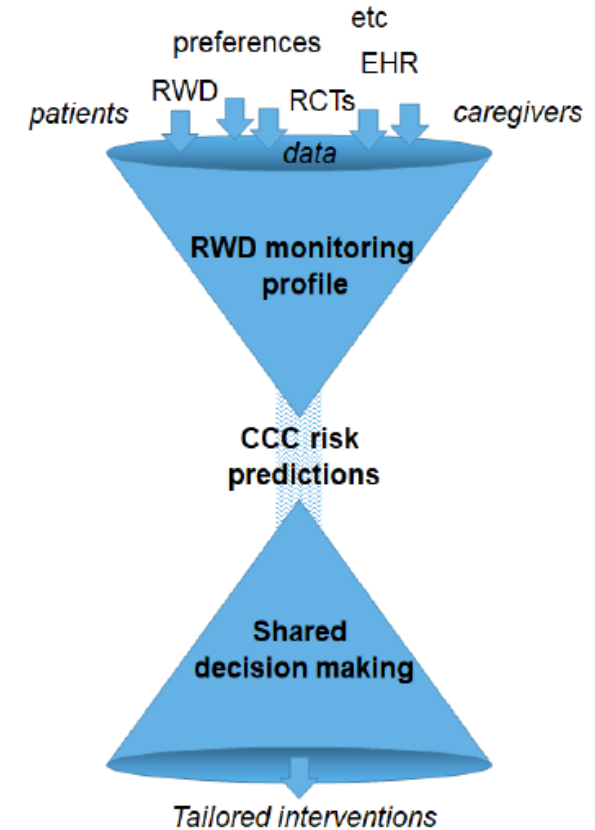

RE-SAMPLE - objectives

- S&T1: A secure, high quality RWD monitoring ecosystem from RWD lakes containing heterogeneous, multimodal and changing data sources
- S&T2: Real-time personalised prediction for the prognostics of multi-morbid exacerbations of CCCs
- S&T3: Secure and privacy-preserving user data management platform for tailored decision making
- S&T4: Virtual companion to provide personalised interventions that empower patients in self-care
- S&T5: Evaluation towards evidence-based care at individual level
- S&T6: Cross-care path integrated care system to drive structural change in healthcare

EXPECTED RESULTS

- 1) new, unique insights in the course and interrelationships between (bio) markers, lifestyle characteristics, and clinical and well-being parameters creating holistic models for the onset and progression of CCC exacerbations;
- 2) a breakthrough in knowledge in timely detecting exacerbations to start preventive treatment effectively;
- 3) definition of clinical endpoints to identify and monitor individual patients with CCCs that can be used in a personalised eHealth application – virtual companionship programme - embedded in daily care
- 4) highly-innovative secure and trustworthy handing of data and machine learning methodology using multiparty computation

RE-SAMPLE

- 4 years: 01.03.2021 - 28.02.2025
- Multidisciplinary consortium: 10 partners (7 EU countries) specialising in respiratory medicine, RWD, artificial intelligence, privacy, ethics, data protection, and health policy



RE-SAMPLE

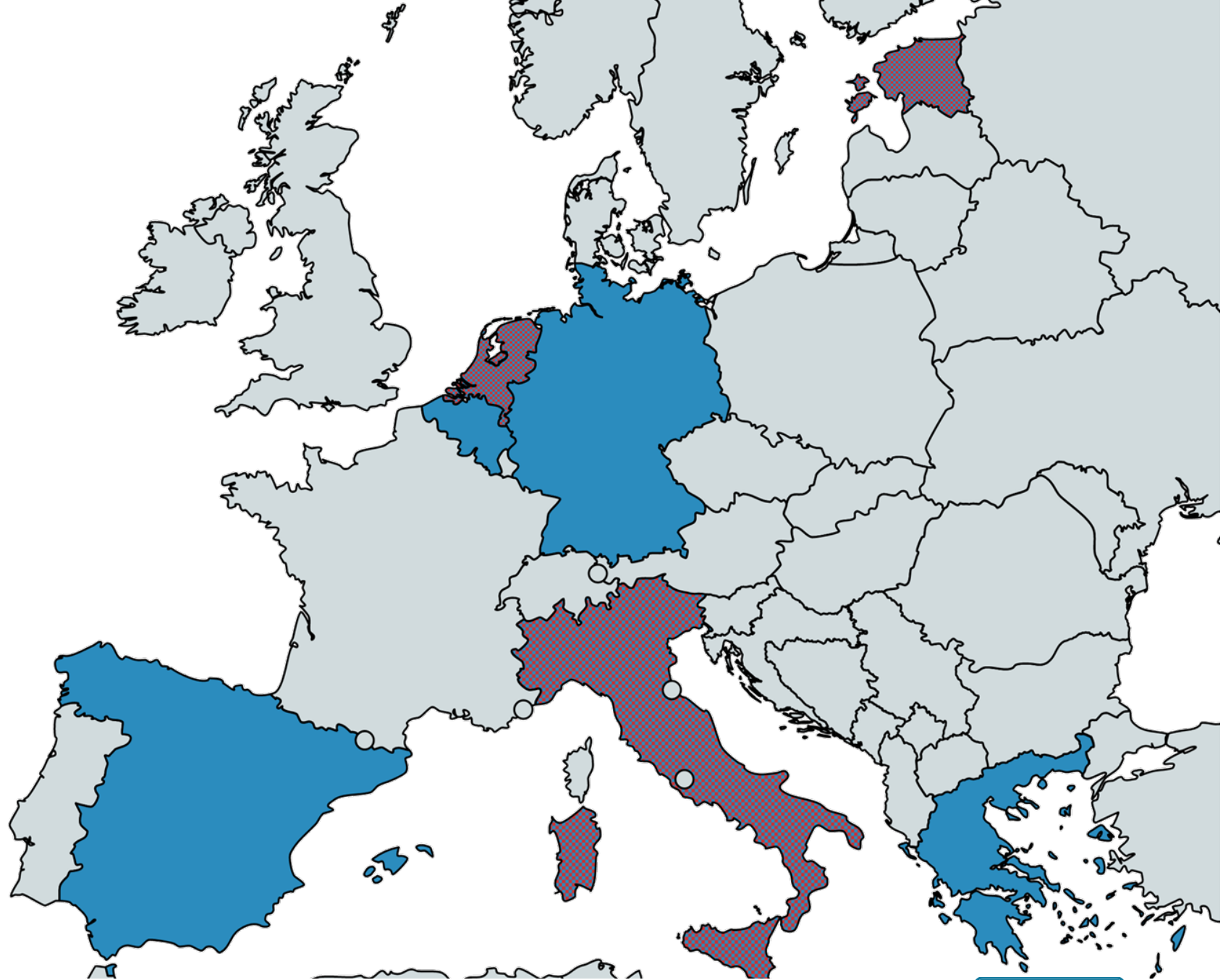

RE-SAMPLE

- 3 Pilot Sites
- Healthentia Cloud and App used by all patients in all pilot sites
- AI Services from patient data
 - Retrospective datasets
 - EHR from hospitals
 - Healthentia
 - Environmental data
- AI service for all patients
- Privacy-by-Design

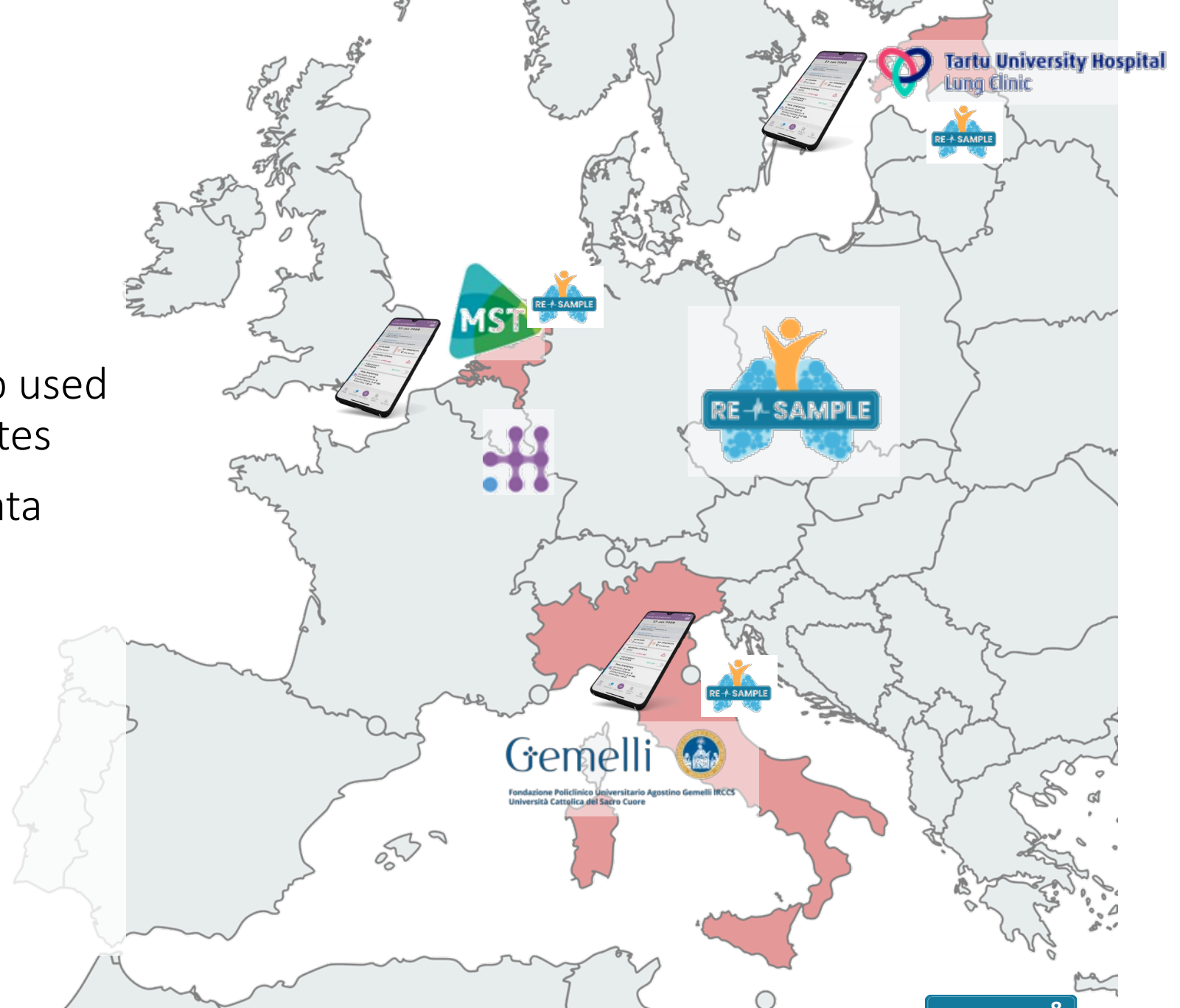

High-Level Architecture

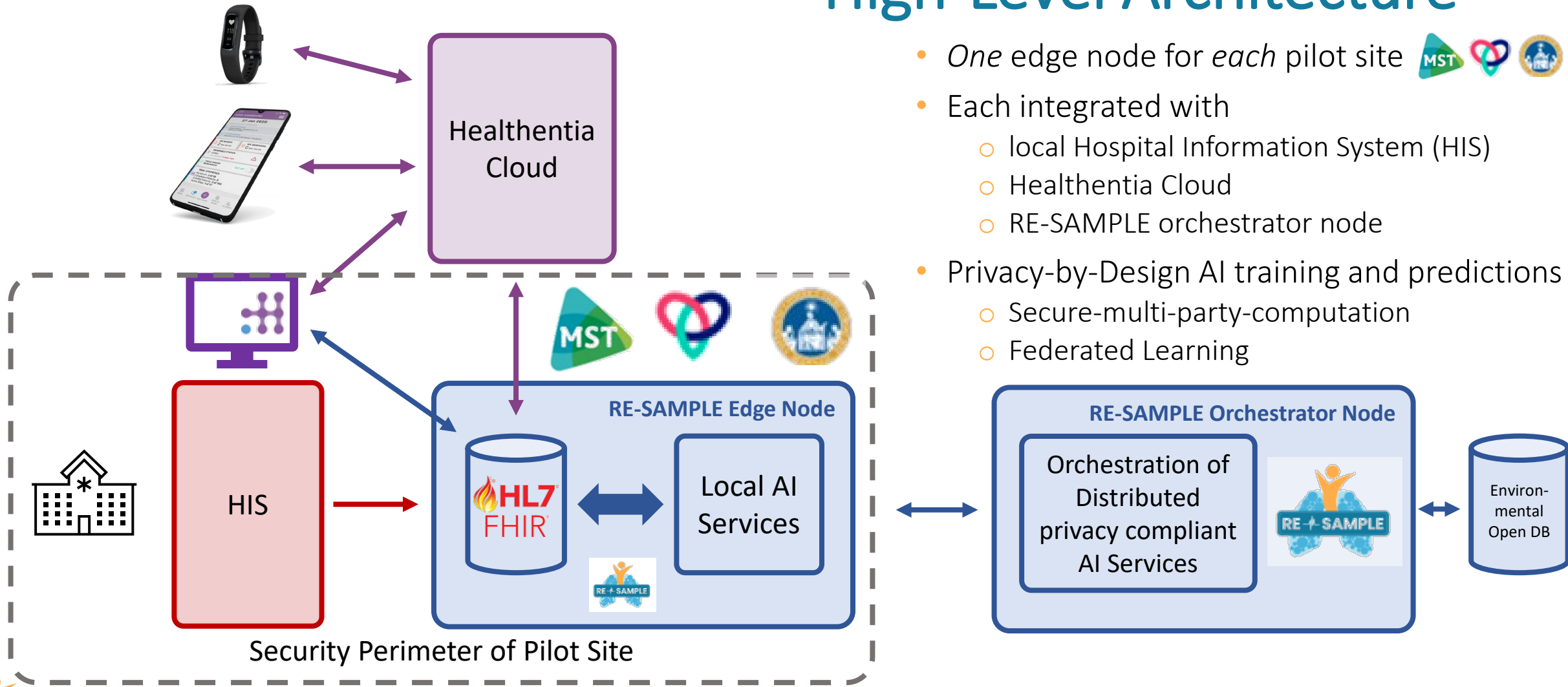

- One edge node for each pilot site
- Each integrated with
 - local Hospital Information System (HIS)
 - Healthentia Cloud
 - RE-SAMPLE orchestrator node
- Privacy-by-Design AI training and predictions
 - Secure-multi-party-computation
 - Federated Learning

RE-SAMPLE Assets

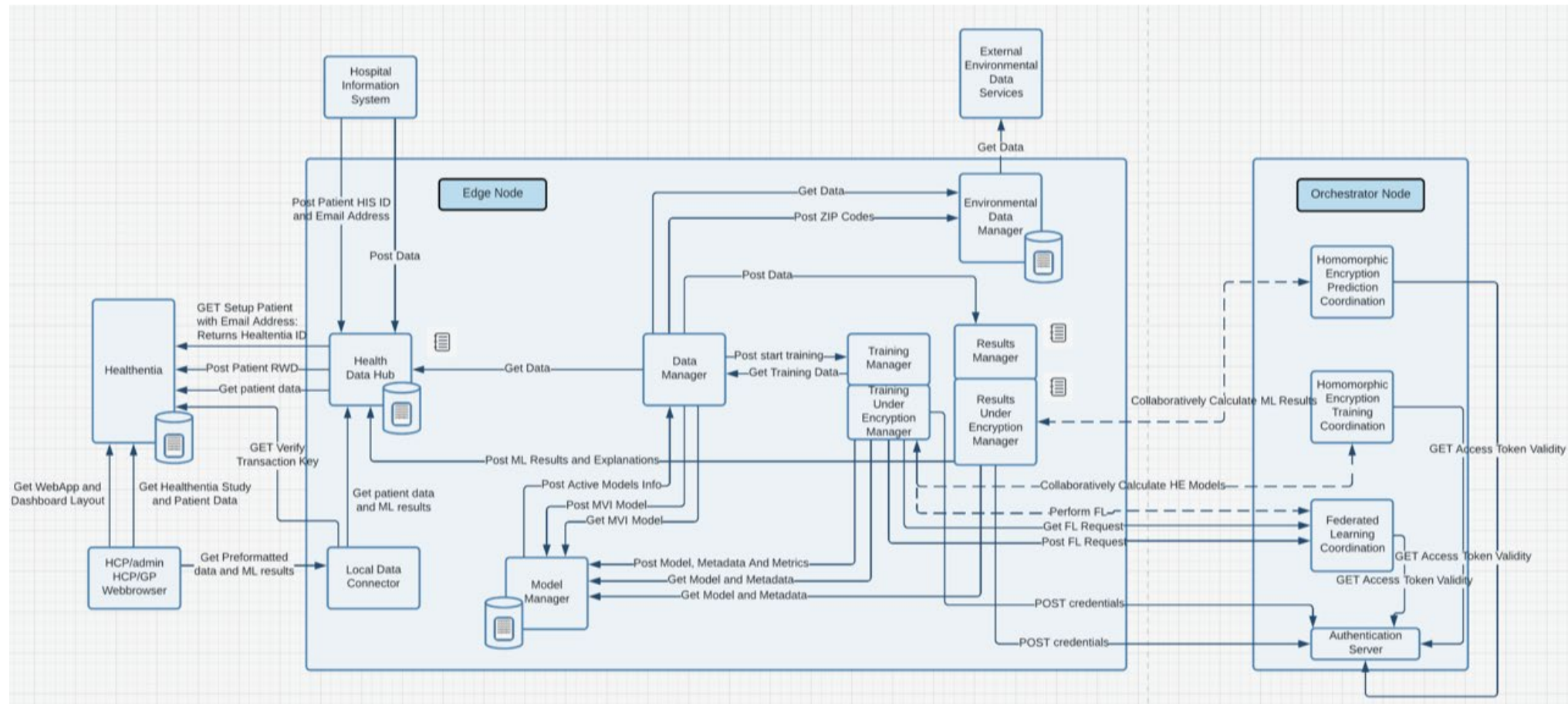

RE-SAMPLE Security Model

Architecture with Security Domains

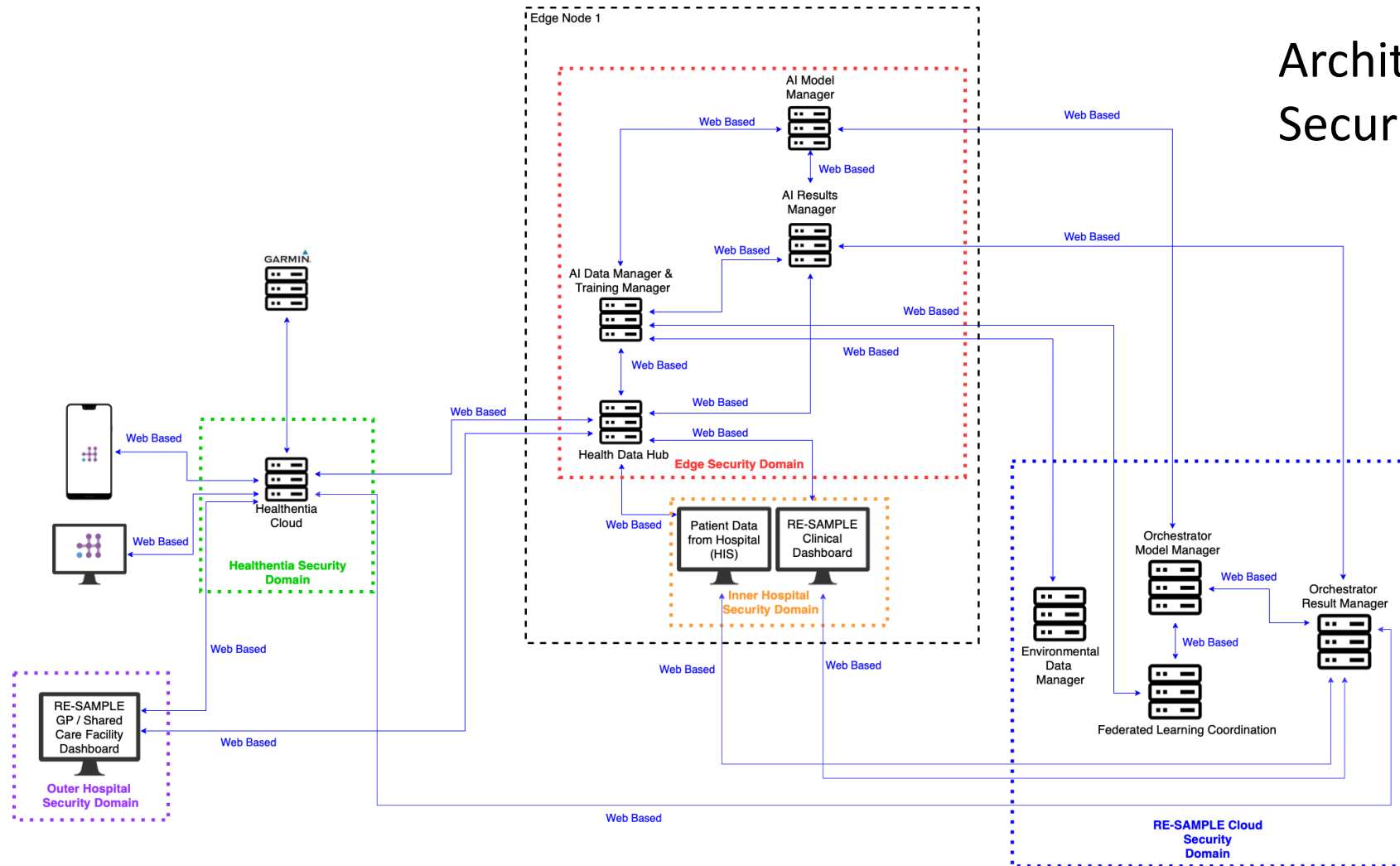

RE-SAMPLE Security Model

- **Authentication and authorization mechanisms**

- Machine-2-Machine, User-2-Machine
- Based on the **Oauth 2.0 and OpenID Connect (OIDC)** protocols
- Development of a **RE-SAMPLE Role Based Access Control** policy

- **De-identification: objectives**

- Patients' pseudonyms (HIS, Healthentia) visible at the interfaces of the Edge Nodes are never stored in the data in the Edge Node
- Patient pseudonyms and location-related information never part of training datasets

- **Hospital Security Perimeter Compliance**

- No incoming connection requests into hospital security perimeters
- Only outgoing connection requests from edge nodes to Healthentia / Orchestrator node

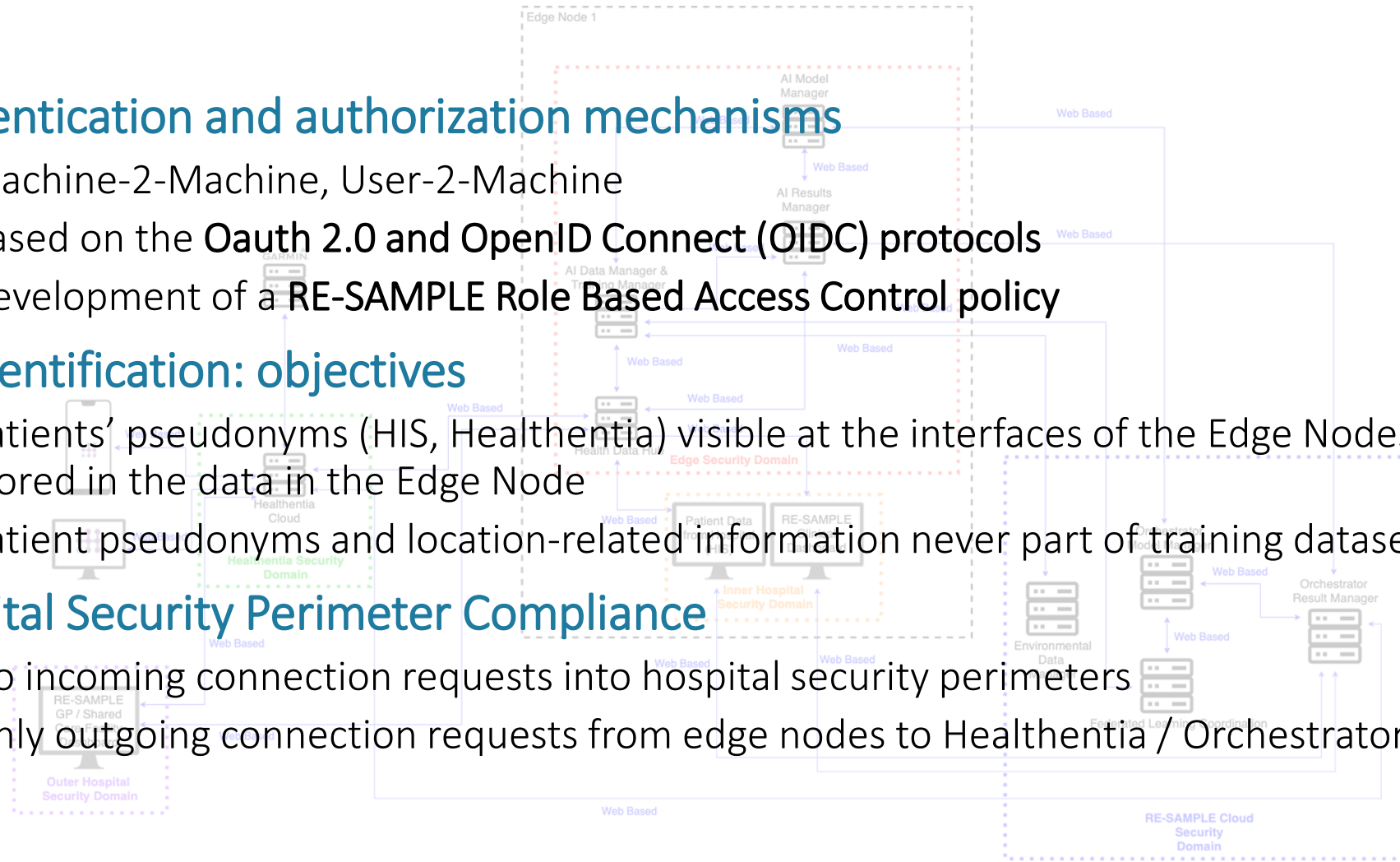

RE-SAMPLE Data and Data Format

Retrospective Datasets

- Data previously collected at all three pilot sites
- Alignment and mapping of different formats

Prospective Datasets

- Collected during cohort studies at pilot sites
- From Hospital Information System, Healthentia, Air quality databases
- Aggregated in pilot site RE-SAMPLE edge nodes
- Uniform HL7 FHIR compliant data format

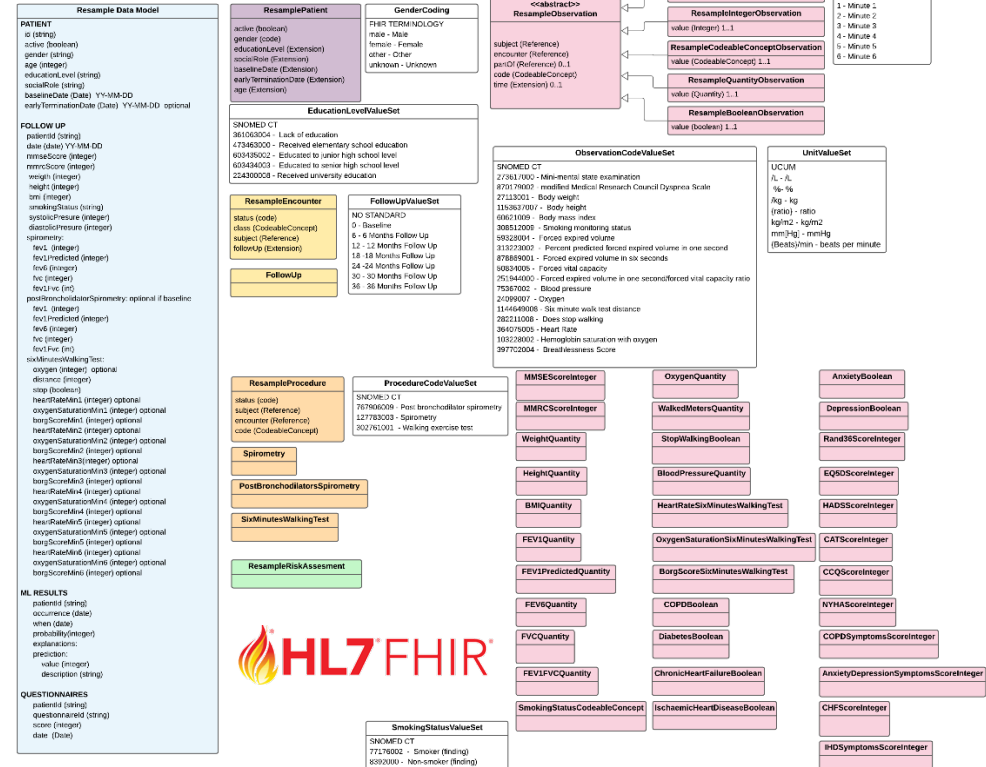

Facts

- Multiple partners collect different types of data
- Data are collected from different sources
- Partners not directly involved in data collection tasks require additional information for training ML models
- Data collected need to pair with:
 - The intended RESAMPLE functionality (user requirements, functional requirements)
 - The RESAMPLE architecture
 - The requirements written in the proposal as the minimum goals that RESAMPLE should fulfil
 - What hospitals can offer (data types) in order to satisfy specific requirements

GDPR Compliance – Internal Agreements

- Customised Consent Forms
- Satisfaction of legal, organisational and technical security and privacy requirements during
 - design and the development stages of all platform components (GAP analysis, DPIA, Risk Analysis)
 - all intermediate studies with user related requirements (user requirements, retrospective data analysis, cohort study)

Currently 3 signed agreements

- Purpose of Processing:
 - Identify predictors and parameters of COPD and CCC progression and multimorbid CCC exacerbations
 - *Retrospective* data of patients with COPD w/o CCC
 - A Joint Controllership Agreement (JCA) between the clinical partners
- Purpose of Processing:
 - Identify predictors and parameters for COPD and comorbid disease progression and multimorbid exacerbations
 - *Retrospective* patient data and *prospective* data from real-world data collected with questionnaires, diaries, and sensing, clinical data
 - Data Processing Agreements (DPA) between the clinical partners and Technical Partners
- Purpose of Processing:
 - Identify predictors and parameters for COPD and comorbid disease progression and multimorbid exacerbations
 - *Prospective* real-world data collected with questionnaires, diaries, and sensing
 - Data Processing Agreements (DPA) between the clinical partners and Healthentia

Risk Analysis

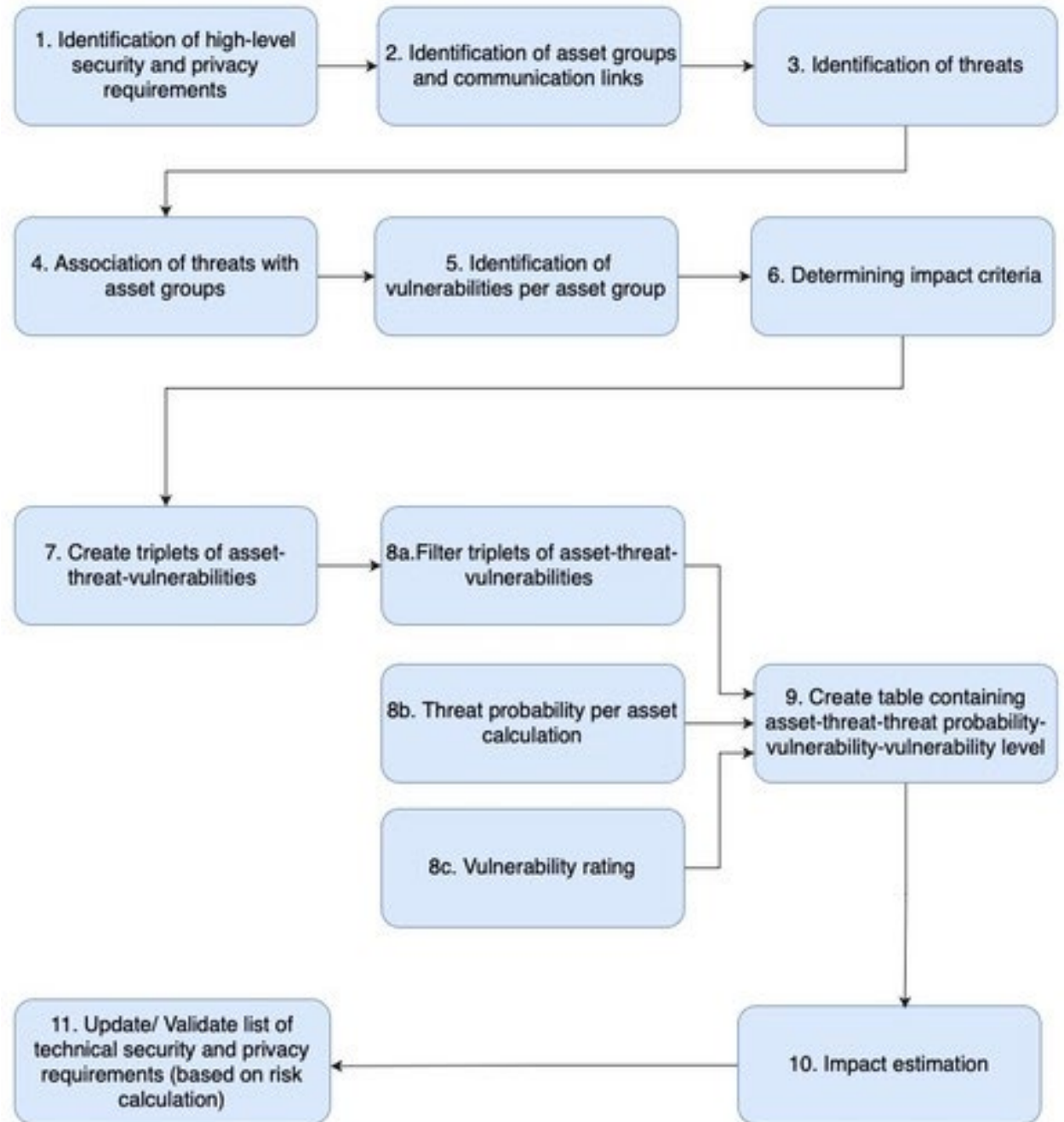

Open Data – Paths suggested

- **We offer anonymized data for a specific purpose of processing ONLY!** In this case we must have informed consent from each patient that allows us to CONDUCT the anonymization and OFFER the anonymized data for the specific purpose of processing. For safeguarding even more the patients' privacy rights, we can grant access to the anonymized data after an access request in the sense that every request is examined and fulfils the defined purpose of processing!
- **We offer anonymized data upon request.** In this case we don't have a specific purpose of processing but we examine each access request individually. In that case we need to take the informed consent of every patient before we conduct the anonymization and grant access of the data to the interested parties. As you understand in this case, we need a separate informed consent from every patient for every access request!

Open Data

- To our understanding **each Hospital will decide what data will provide** (as open data) **and for what purposes**. As such, each clinical partner should go ahead and define the “purposes of processing” for which the anonymized data can be provided to a third party (this set of purposes may be different for each clinical partner).
- **Each clinical partner will be responsible for conducting the anonymization** of the data that will offer.
- **Each clinical partner will be responsible to include a statement** (regarding anonymization and open data) **in the informed consent for the patients** (if all the above are correct and agreed, we will help preparing this statement).
- **The technical partners should neither provide any open data nor should be involved in the anonymization of the data.**

Thank you for your attention!

chkallon@unipi.gr

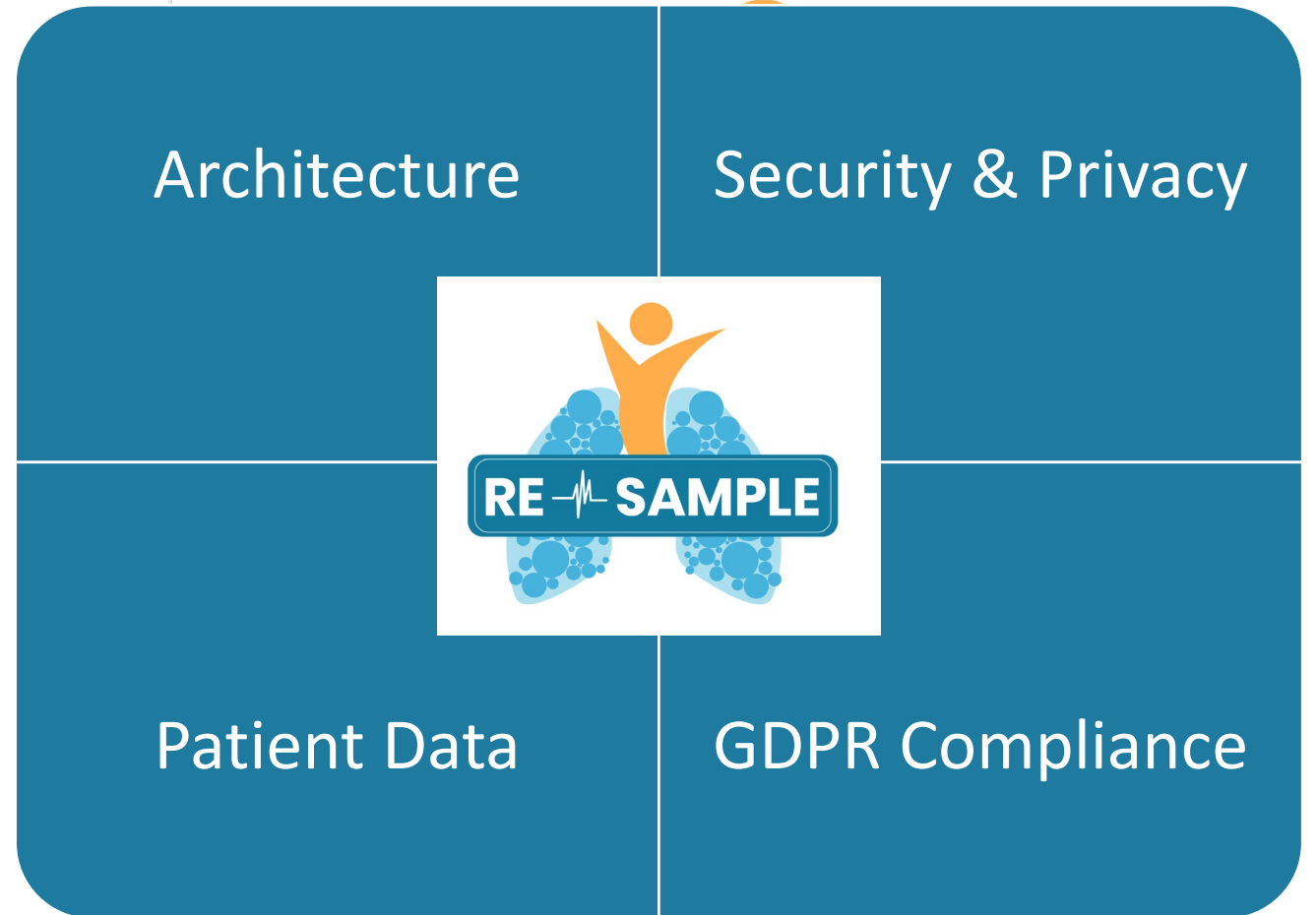

RE-SAMPLE has received funding from the European Union's Horizon 2020 research and innovation programme under Grant Agreement No 965315. SC1-DTH-12-2020: Use of Real-World Data to advance research on the management of complex chronic conditions. This result only reflects the author's view and the EU is not responsible for any use that may be made of the information it contains.